

## Sink S4000

Bowl on the left

Kitchen Sinks

Code: 4315 052

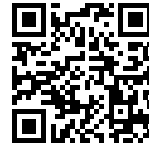

### DETAILS

|                        |   |
|------------------------|---|
| Edge/Installation Type | Flush-mount   Top-mount   |
| Finish                 | Foster brushed  |
| Material               | AISI 304 stainless steel  |
| Texture                | Foster brushed  |
| Base                   | 80 cm   |
| Dimensions             | 1173x513 mm   |
| Standard fittings      | Fixing hooks, gasket, drain, overflow and siphon, boxed packing |
| Mixer holes            | 1 standard hole   |
| Built-in hole          | View technical data sheet                                       |

Drainer Yes

---

Width 117 cm

---

Bowl dimension 340x400mm

---

Number of bowls 2 bowls

---

Waste fitting 3,5" drain

---

## FEATURES

**High thickness** 1mm thick steel. A significant thickness, which guarantees the maximum sturdiness and durability.

---

**Basket 3,5" waste fitting** The drain is equipped with a large 3.5" drain, with the practical basket cap that prevents the discharge of solid parts.

---

**Perimetral overflow** The overflow is always a security on the Foster sinks that prevents the overflow of water in case of oversights. The perimeter drain solution improves aesthetics thanks to its square and essential shape.

---

**Small radius** Bowls with squared shapes with a modern design and an increased capacity, for a minimal aesthetics connected with an extreme practicality.

---

**Deep bowls** This bowls reach an important depth, over 20 cm, thanks to the advanced production technology, that can be offer great capieny and practicality in all the washing operations.

---

## TECHNICAL DATA

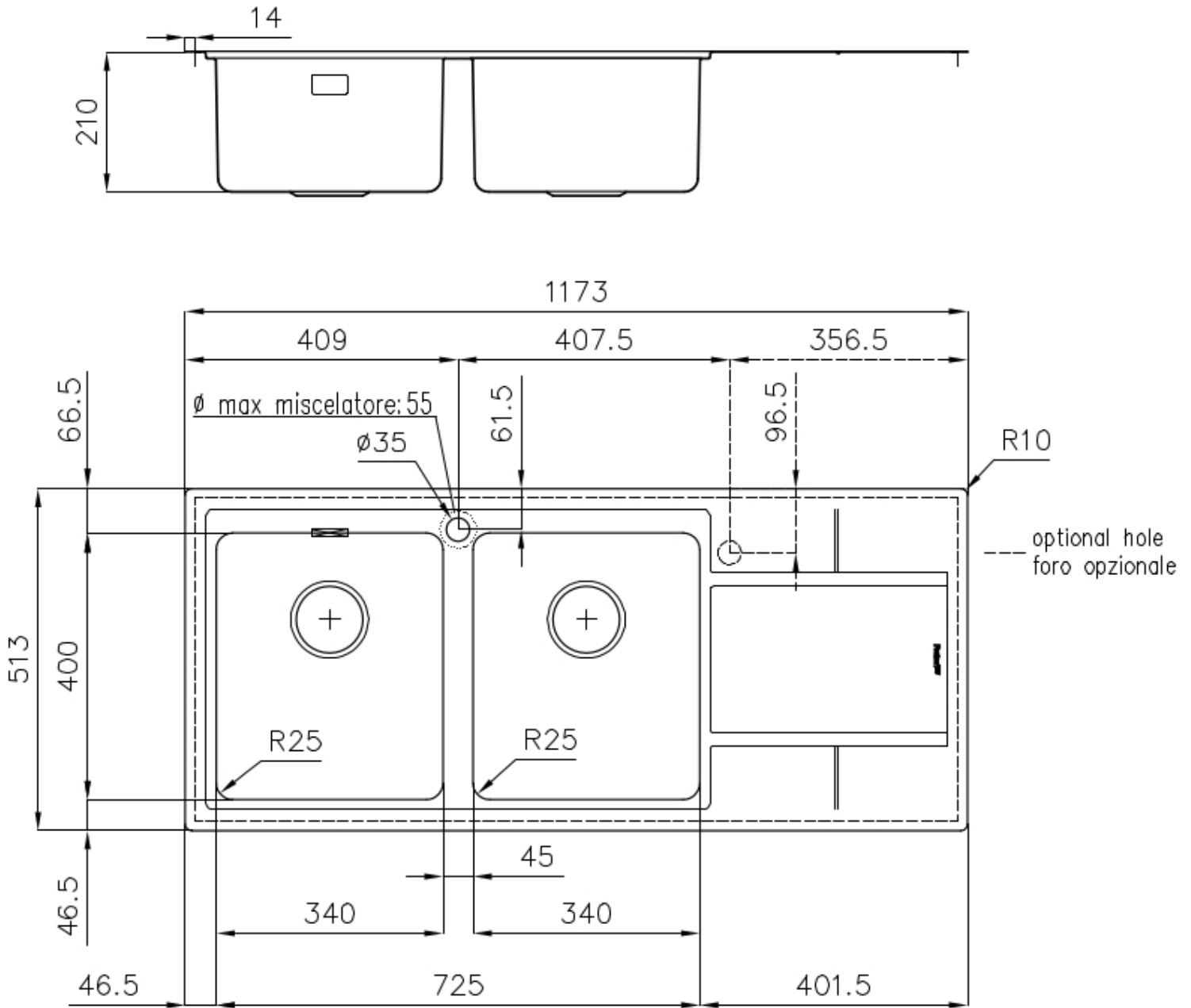

## Lavello S4000 cod. 4315/05\*

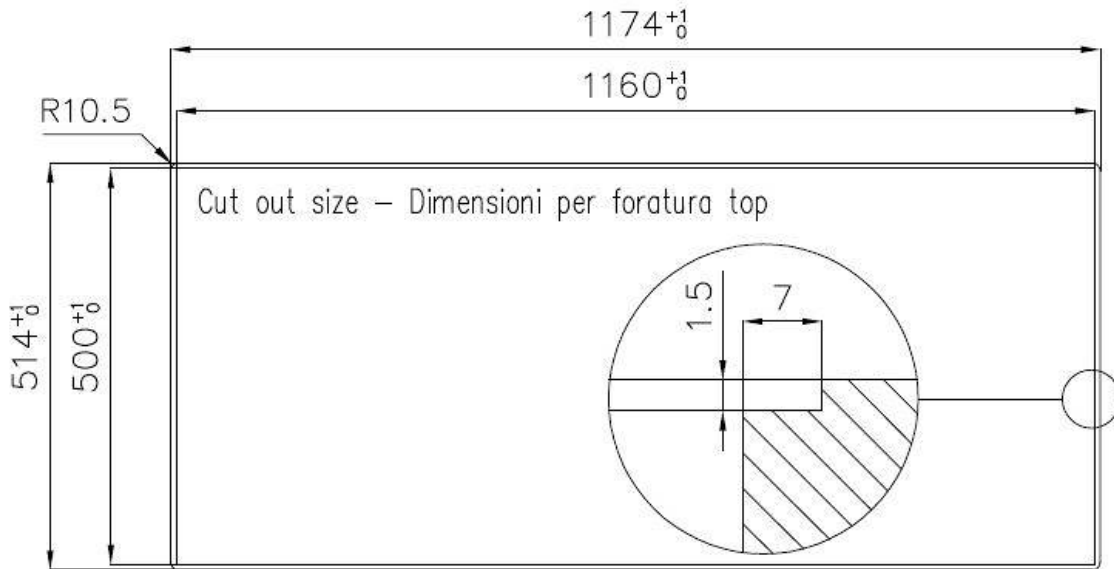

FT

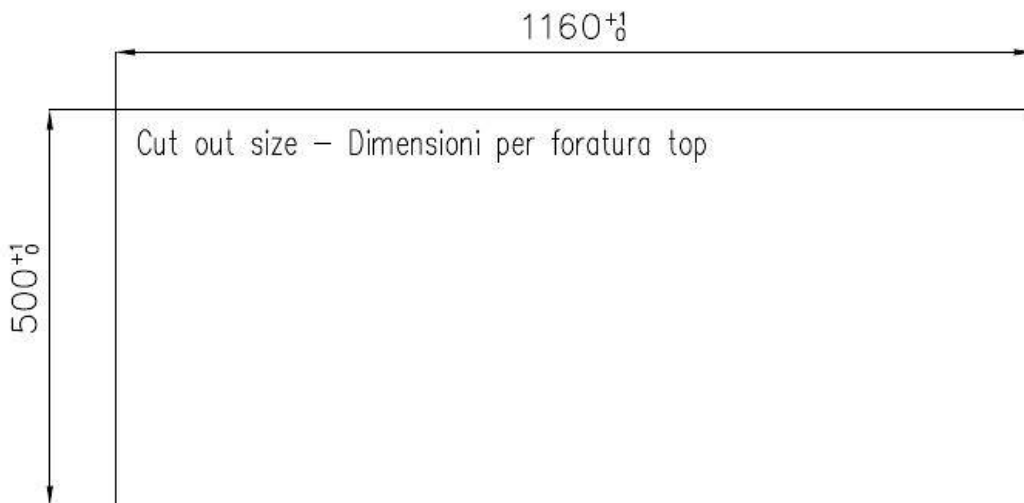

FTS

### GALLERY

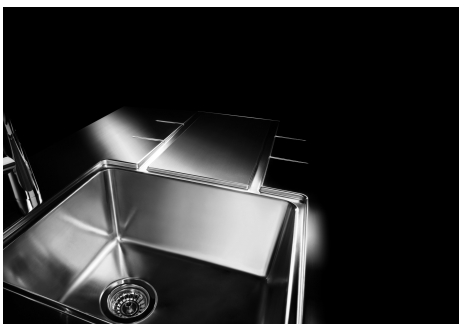

## OPTIONAL ACCESSORIES



**Glass chopping board**  
8631 300



**HPDE Chopping board**  
8657 001



**HPDE Twin chopping board**  
8644 101



**Stainless steel basket**  
8611 000

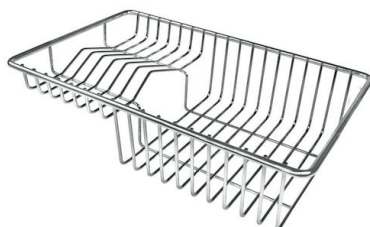

**Stainless steel plate rack**  
8100 303  
\* only in combination with the accessory  
8644 101

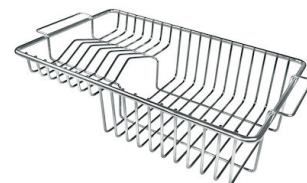

**Stainless steel plate rack**  
8100 201



**White bowl**  
8153 100



**Graters kit with ring-holder and  
food collection tray**  
8159 101  
\* only in combination with the accessory  
8644 101



**Stainless steel perforated tray**  
8151 000  
\* only in combination with the accessory  
8644 101

## RECOMMENDED PAIRINGS



**Mixer Tap Camillo**  
8467 000



**Mixer Tap Play**  
8487 000